

CS540™

Wireless Headset System

Designed in Santa Cruz, California

Guía de inicio rápido
Guide de démarrage rapide
Guia de Início Rápido

QUICK START GUIDE



plantronics

1 Select Wearing Style

1 Choose headset wearing style, using guide to assemble.

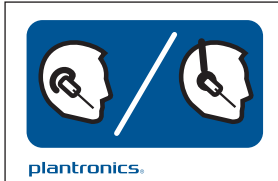

Over the ear OR Over the head

2 Charge Headset

1 Plug one end of power supply into power jack on back of the base and other end into working power outlet.

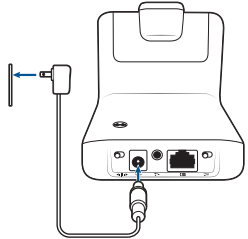

2 To charge, dock headset in base for minimum of 20 minutes.

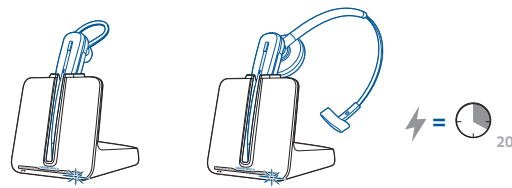

CS540™

Sistema de auriculares inalámbricos

Diseñado en Santa Cruz, California

GUÍA DE INICIO RÁPIDO

plantronics

1 Cómo seleccionar el modo de uso

1 Elija el modo de uso del auricular; para armarlo, use la guía.

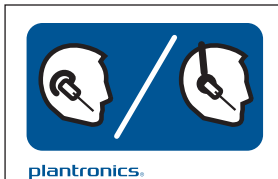

Sobre la oreja O sobre la cabeza

2 Cómo cargar el audífono

1 Enchufe un extremo del suministro eléctrico en el conector hembra en la parte trasera de la base y el otro extremo en la salida del tomacorriente que está funcionando.

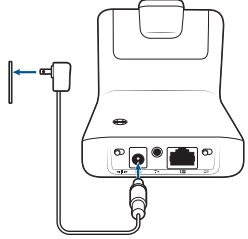

2 Para cargar, coloque el auricular en la base durante 20 minutos como mínimo.

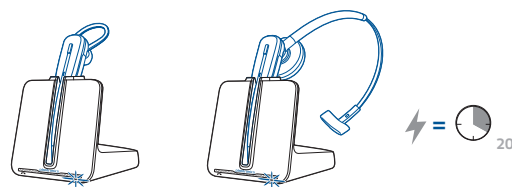

3 Connect Desk Phone

1 Connect cables from desk phone to base.

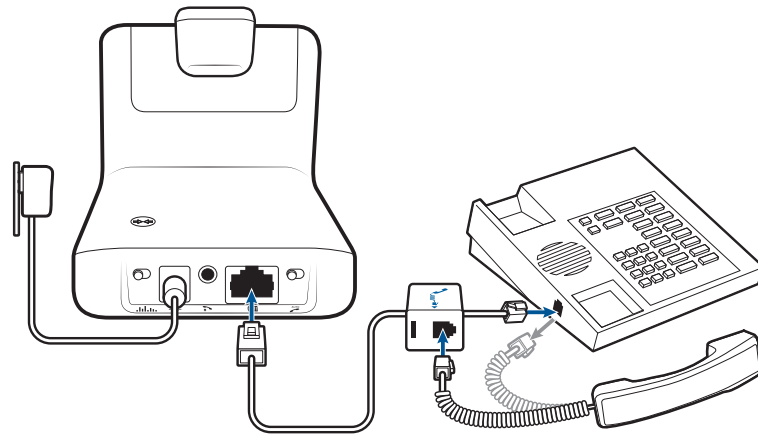

4 Make a Call

1 While wearing headset, tap call control button.

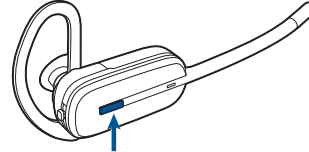

2 Remove the desk phone handset.

3 Dial test call from desk phone.

NOTE You may also call the automated sound test at 800-317-8308. It's the quickest way to test and optimize your system.

4 End call by pressing headset call control button and hang up the handset.

Troubleshooting Tip: If you do not hear a dial tone, adjust the slide switch (A–G) until you do. Default setting **A** works for majority of desk phones.

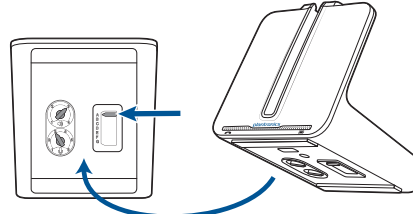

NOTE For remote call control capability (HL10 lifter or EHS cable), see plantronics.com/accessories.

⚠️ Avoid touching the contacts at the rear of the unit unnecessarily. If operation is interrupted by a static event, power-cycle the product to restore normal functions.

NEED MORE HELP?

Technical support
plantronics.com/support
Online user guide
<http://docs.plantronics.com/cs500>

System Features

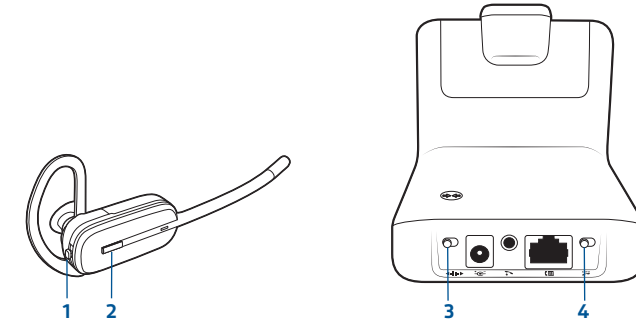

1 **Volume/Mute button**

Increase volume Press up*

Decrease volume Press down*

*If charged worn on the left side, up and down positions are reversed.

Mute Press in (base LED solid red)

2 **Call Control Button**

Answer/end call Tap

3 **Narrowband/Wideband Audio Switch**

Black Narrowband Audio

Yellow Wideband Audio (desk phone must be capable of wideband audio)

NOTE Talk time will be reduced when operating in wideband mode.

4 **Auto Answer Switch**

Black (off) Tap call control button to place or answer call

Gray (on) Lift headset from base to place or answer call

Your CS540 consists of a C054 base and a C540 headset.

Plantronics, Inc.
345 Encinal Street
Santa Cruz, CA 95060
United States

©2013 Plantronics, Inc. All rights reserved. Plantronics and CS540 are trademarks or registered trademarks of Plantronics, Inc. All other trademarks are the property of their respective owners.
Patents US D635,548; D635,962; EM 001792276-0002; 001792276-0003; Patents Pending



Recyclable where facilities exist

Limited Warranty
Plantronics offers a one (1) year limited warranty on this product. Please note that the duration of the warranty depends on the laws of your country. For full warranty details, conditions and technical assistance, please visit our website: plantronics.com/support. 1-800-544-4660, 831-426-5858

Safety Instructions
Please read the following safety and operational instructions before using this product. Please keep these instructions for your reference. When using this product, these basic safety precautions and warnings should be followed to reduce the risk of fire, electric shock, injury to persons and damage to property. Additional warnings may be present on the product, packaging, or in the user instructions.

General

Operating, storage and charging temperature is 0°C to 40°C (32°F to 104°F).

⚠️ Warnings

- Use only those Plantronics products and accessories designed for use with this Plantronics system.
- CHILDREN: Never allow children to play with the product—small parts may be a choking hazard.
- Install and use earbuds and earbuds in accordance with the instructions provided. Do not force earbuds or earbuds down the ear canal. If either becomes lodged in the ear canal, seek medical attention immediately.
- Ensure earbuds and earbuds are kept clean and free of ear wax buildup to maintain the specified product performance.

• Observe all signs and instructions regarding the use of an electrical device or RF radio product in designated areas, such as gas/fueling stations, hospitals, blasting areas, potentially explosive atmospheres, or aircraft.

• Do not disassemble the product or AC adapter as this may expose you to dangerous voltages or other risks. Incorrect reassembly can cause electric shock or fire when the product is subsequently used.

• Do not insert anything into the product or charger because this may cause damage to the internal components or cause injury to you.

• Avoid contact with liquids. Do not locate this product near water, for example, near a bathtub, or sink, in a wet basement, or near a swimming pool to protect against damage to the product or injury to you.

• Discontinue use of product and contact Plantronics if the product overheats, has a damaged cord or plug, if the product has been dropped or damaged, or if the product has come into contact with liquids.

• This product should never be placed over or near a heat source and should not be placed in locations which do not have proper ventilation.

• If you experience a skin irritation after using this product, discontinue use and contact Plantronics.

• Exposure to high volume sound levels may cause temporary or permanent damage to your hearing. Although there is no simple volume setting that is appropriate for everyone, you should always use your headset with the volume set at moderate levels and avoid prolonged exposure to high volume sound levels. The louder the volume, the less time is required before your hearing could be affected. You may experience different sound levels when using your headset with different devices. The device you use and its settings affect the level of sound you hear. If you experience hearing discomfort, you should stop listening to the device through your headset and have your hearing checked by your doctor. To protect your hearing, some hearing experts suggest that you:

1. Set the volume control in a low position before putting the headset on your ears and use as low a volume as possible.
2. Avoid turning up the volume to block out noisy surroundings. Whenever possible, use your headset in a quiet environment with low background noise.
3. Limit the amount of time you use headsets at high volume levels.
4. Turn the volume down if the sound from the headset prevents you from hearing people speaking near you. See plantronics.com/healthandsafety for more information on headsets and hearing.

⚠️ Charging Warnings
• Use only the charger supplied by Plantronics to charge the product. Do not use the chargers for any other purpose. Ensure that the voltage rating corresponds to the power supply you intend to use, for example 100-240 V; 50/60 Hz; 0.2 A.

• Charge the headset according to the instructions supplied with the unit.

• Plug the AC adapter or charger into an outlet that is near the equipment and will be easily accessible.

• Never store or use the product or charge the battery where the temperature may fall below 0°C (32°F) or rise above 40°C (104°F).

⚠️ Headset Battery Warnings
To avoid the risk of explosion, fire or leakage of toxic chemicals, please observe the following warnings:

- Do not dispose of the product or battery in a fire or heat above 40°C (104°F).
- Do not open, deform or mutilate the battery. There may be corrosive materials which can cause damage to eyes or skin and may be toxic if swallowed.

• Always store batteries where children cannot reach them.

• If your product has an embedded, non-replaceable battery, it is designed to last the life time of the product. Do not attempt to open the product or remove the battery as this may cause injury and damage the product. Please contact the local recycling facility for removal of the battery.

• If your product has a replaceable battery, use only the battery type supplied by Plantronics. Remove a spent battery promptly.

• Do not allow any battery or its holder to contact metal objects such as keys or coins.

RECYCLING: Your headset and/or the battery must be recycled or disposed of properly. Contact your local recycling center for proper disposal of your headset.

NOTE For instructions on placing this product in "test mode" for battery charger efficiency testing, please contact Plantronics at 1-855-765-7878.

FCC Requirements Part 15
Note: This equipment has been tested and found to comply with the limits for a Class B digital device, pursuant to part 15 of the FCC Rules. These limits are designed to provide reasonable protection against harmful interference in a residential installation. This equipment generates, uses, and can radiate radio frequency energy and, if not installed and used in accordance with the instructions, may cause harmful interference to radio communications. However, there is no guarantee that interference will not occur in a particular installation. If this equipment does cause harmful interference to radio or television reception, which can be determined by turning the equipment off and on, the user is encouraged to try to correct the interference by one or more of the following measures:

1. Reorient or relocate the receiving antenna.
2. Increase the separation between the equipment and receiver.
3. Connect the equipment into an outlet on a circuit that is not on the same circuit as the receiver is connected.
4. Consult the dealer or an experienced radio/TV technician for help.

FCC Registration Information – Part 68
This equipment complies with Part 68 of the FCC rules and the requirements adopted by ACTA. On the exterior of this equipment is a label that contains a product identifier in the format USAAQWPTXXX. If requested, this information must be provided to your telephone company. A plug and jack used to connect this equipment to the premises wiring and telephone network must comply with the applicable FCC Part 68 rules and requirements adopted by ACTA. A compatible telephone cord and modular plug is provided with this product. It is designed to be connected to a compatible jack that is also compliant. See installation instructions for details.

The REN is used to determine the quantity of devices you may connect to your telephone line. Excessive RENs on a telephone line may result in the device not operating in response to an incoming call. In most, but not all areas, the sum of the RENs should not exceed five (5.0). To be certain of the number of devices you may connect to your line, as determined by the REN, contact your local telephone company. For products approved after August 8, 2002, the REN for this product is part of the product identifier that has the format USAAQWPTXXX. The digits represented by #1# are the REN without the decimal point. (For example, 03 represents a REN of 0.3) For earlier products, the REN is separately shown on the label.

If this telephone equipment causes harm to the telephone network, the telephone company will notify you in advance that temporary discontinuance of service may be required. But if advance notice isn't practical, the telephone company will notify the customer as soon as possible. Also, you will be advised of your right to file a complaint with the FCC. You believe it is necessary.

The telephone company may make changes in its facilities, equipment, operations, or procedures that could affect the proper functioning of your equipment. If they do, you will be notified in advance in order for you to make necessary modifications to maintain uninterrupted service. If trouble is experienced with this unit, for repair or warranty information, please contact customer service at (800) 544-4660. If the equipment is causing harm to the network, the telephone company may request that you disconnect the equipment until the problem is resolved.

DO NOT DISASSEMBLE THIS EQUIPMENT: It does not contain any user-serviceable components.
We recommend the installation of an AC surge arrester in the AC outlet to which this equipment is connected. Telephone companies report that electrical surges, typically lighting transients, are very destructive to customer terminal equipment connected to AC power sources.

Exposure to RF Radiation
The internal wireless radio operates within the guidelines found in radio frequency safety standards and recommendations, which reflect the consensus of the scientific community. Independent studies have shown that the internal wireless radio is safe for use by consumers. Visit plantronics.com for more information.
In order to comply with FCC and IC REE exposure requirements, the base must be installed and operated such that a minimum separation distance of 20 cm is maintained between the base and all persons during normal operation. The headset complies with FCC radiation limits set forth for an uncontrolled environment.
NOTE: Modifications not expressly approved by Plantronics, Inc. could void the user's authority to operate the equipment.

3 Cómo conectar el teléfono de escritorio

1 Conecte los cables del teléfono de escritorio a la base.

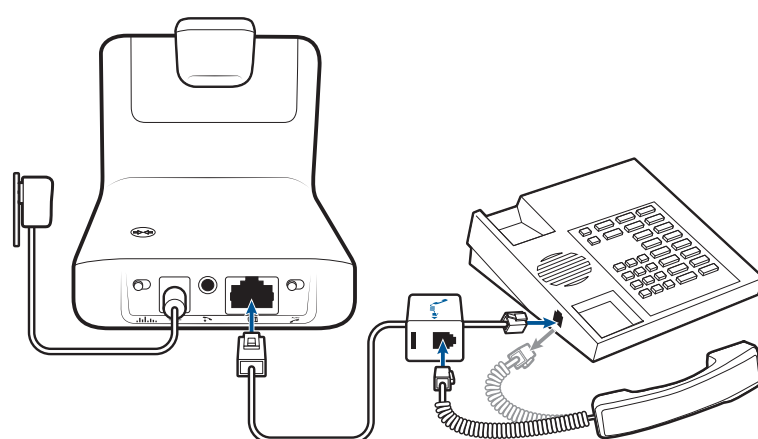

4 Cómo hacer una llamada

1 Con el auricular colocado, toque el botón de control de llamadas.

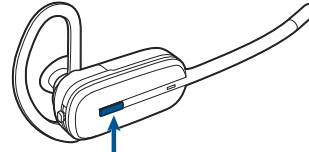

2 Levante el tubo del teléfono de escritorio.

3 Realice una llamada de prueba desde el teléfono de escritorio.

Funciones del sistema

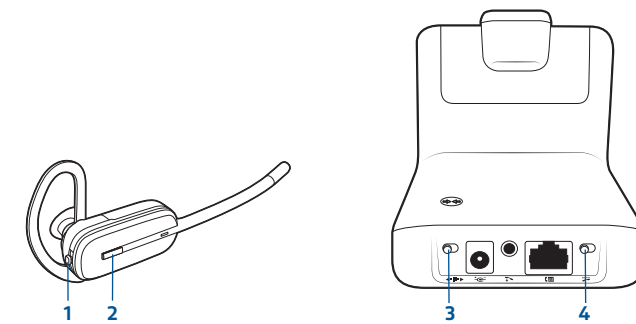

1 **Botón de volumen/silencio**

Aumentar el volumen Presionar hacia arriba*

Bajar el volumen Presionar hacia abajo*

*Si el auricular se usa del lado izquierdo, las posiciones arriba y abajo se revierten.

2 **Botón de control de llamadas**

Responder/finalizar llamada Tocar

3 **Interruptor de audio de banda ancha/estrecha**

Negro: audio de banda estrecha

Amarillo: audio de banda ancha (el teléfono de escritorio debe tener capacidad para audio de banda ancha)

NOTE Se reducirá el tiempo de conversación al operar en modo de banda ancha.

4 **Respuesta automática Conmutador**

Negro (apagado) Toque el botón de control de llamadas para realizar o responder una llamada

Gris (encendido) Levante el auricular de la base para realizar o responder una llamada

Su CS540 incluye una base C054 y un auricular C540.

¿NECESITA MÁS AYUDA?

Asistencia técnica
plantronics.com/support
Guía del usuario en línea
<http://docs.plantronics.com/cs500>



CS540™

Système de micro-casque sans fil

Conçu à Santa Cruz, en Californie

GUIDE DE DÉMARRAGE RAPIDE

plantronics

1 Choix du port du micro-casque

1 Choisissez un style de port du micro-casque et aidez-vous du guide pour l'assembler.

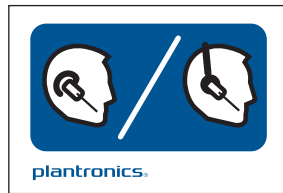

Contour d'oreille OU serre-tête

2 Recharge du micro-casque

1 Branchez une extrémité du cordon d'alimentation dans la prise arrière de la base et l'autre dans une prise de courant fonctionnelle.

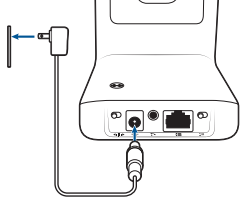

2 Pour recharger le micro-casque, connectez-le à la base pendant au moins 20 minutes.

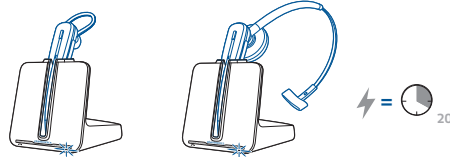

3 Connexion au téléphone de bureau

1 Connectez les câbles du téléphone de bureau à la base.

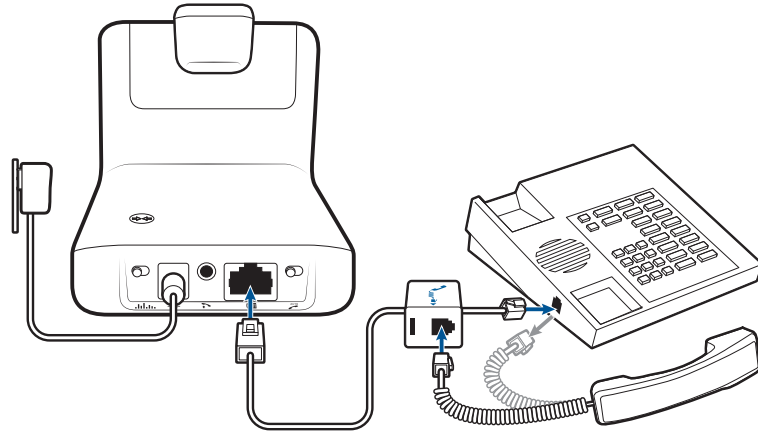

4 Effectuer un appel

1 Une fois le micro-casque installé, appuyez sur le bouton de contrôle des appels.

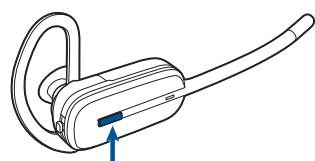

2 Décrochez le combiné du téléphone de bureau.

3 Procédez à un appel d'essai à partir du téléphone de bureau.

REMARQUE Vous pouvez également appeler le test de son automatisé au 800-317-8308. C'est la façon la plus rapide de tester et d'optimiser votre système.

4 Terminez l'appel en appuyant sur le bouton de contrôle des appels du micro-casque et en raccrochant le combiné.

Conseil de dépannage : si vous n'entendez pas la tonalité, changez la position du bouton coulissant (A-G) jusqu'à ce que vous l'entendiez. La configuration par défaut **A** fonctionne avec la majorité des téléphones de bureau.

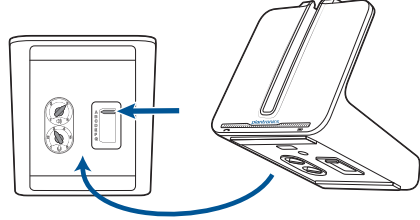

REMARQUE Pour la fonction de contrôle des appels à distance (décrocheur HL10 ou câble de commutateur électronique), voir plantronics.com/accessories.

BESOIN D'AIDE SUPPLÉMENTAIRE?

Soutien technique
plantronics.com/support
Guide de l'utilisateur en ligne
<http://docs.plantronics.com/cs500>

Caractéristiques du système

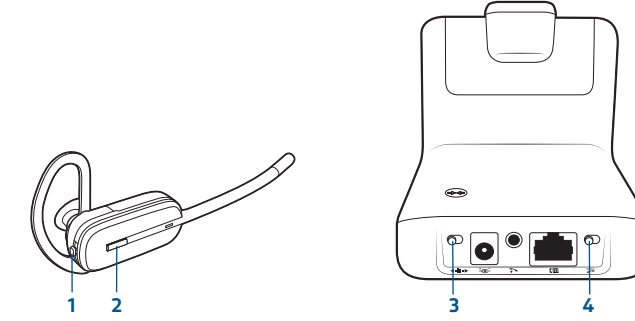

1 Touche de volume/sourdine

Augmenter le volume Appuyez vers le haut*
Diminuer le volume Appuyez vers le bas*
*Si le micro-casque est porté côté gauche, les positions vers le haut et vers le bas sont inversées.

Discrétion Appuyez sans exercer de mouvement (voyant rouge vif sur la base)

2 Bouton de contrôle des appels

Appuyer pour répondre/terminer un appel

3 Bouton de changement de bande passante audio

Noir Bande audio étroite

Jaune Audio large bande (le téléphone de bureau doit prendre en charge l'audio en bande large)

REMARQUE : l'autonomie de conversation est réduite en mode large bande.

4 Bouton de réponse automatique

Noir (arrêté), appuyez sur le bouton de contrôle des appels pour appeler ou répondre à un appel

Gris (marche), soulevez le micro-casque de la base pour appeler ou répondre à un appel

Votre CS540 comprend une base C054 et un micro-casque CS540.

Garantie limitée
Plantronics offre un (1) an de garantie limitée sur ce produit. La durée de validité de la garantie peut différer selon les lois de votre pays. Pour consulter les détails et conditions de la garantie, visitez le site www.Plantronics.com. (800) 544-4660

Renseignements sur la sécurité
Veuillez lire les renseignements suivants sur la sécurité et le fonctionnement avant d'utiliser ce produit. Veuillez conserver ces instructions pour consultation ultérieure. Lorsque vous utilisez ce produit, vous devez prendre certaines précautions de base pour réduire le risque d'incendie, de choc électrique, de blessure et pour éviter tout dommage matériel. D'autres avertissements peuvent figurer sur l'appareil, sur l'emballage ou dans les instructions.

Généralités
Le plage de température d'utilisation, d'entreposage et de chargement de l'appareil est de 0 °C à 40 °C (32 °F à 104 °F).

Avertissements
• N'utilisez que les produits et accessoires Plantronics spécialement conçus pour ce système.
• ENFANTS: Ne laissez pas les enfants jouer avec le produit; ils risqueraient de s'étouffer avec les petites pièces.
• Installez les embouts et les écouteurs-boutons conformément aux instructions. Ne forcez pas les embouts et les écouteurs-boutons dans le canal auditif. Si l'un ou l'autre se coincent dans le canal auditif, consultez un médecin immédiatement.
• Pour des performances optimales, assurez-vous que les embouts et les écouteurs-boutons sont exempts de cérumen.
• Respectez toutes les enseignes et directives concernant l'utilisation d'un appareil électrique ou à ondes radio dans les zones désignées, comme les stations d'essence, les hôpitaux, les zones de dynamitage, les atmosphères potentiellement explosives et les avions.
• Ne démontez pas le produit ou l'adaptateur c.a. car cela peut vous exposer à des tensions dangereuses ou à d'autres risques. Un mauvais remontage de l'appareil pourrait causer un choc électrique lors d'une utilisation ultérieure du produit.
• N'insérez rien dans le micro-casque ou le chargeur; vous pourriez endommager les composants internes ou vous blesser.
• Évitez tout contact avec des liquides. Ne placez pas le produit près d'une source d'eau ou d'humidité, par exemple près d'une baignoire, d'un évier ou d'une piscine ni dans un sous-sol humide, afin d'éviter tout dommage au produit ou toute blessure éventuelle.
• Cessez d'utiliser le produit et communiquez avec Plantronics en cas de surchauffe, de prise ou de cordon endommagé, si vous avez laissé tomber le produit ou s'il est endommagé, ou si le produit est entré en contact avec des liquides.
• Ce produit ne doit jamais être placé près d'une source de chaleur ni dans un endroit où la ventilation est inadéquate.
• Si une irritation de la peau se manifeste après avoir utilisé ce produit, cessez de l'utiliser et communiquez avec Plantronics.
• Une exposition à un volume sonore élevé peut endommager votre ouïe de manière temporaire ou permanente. Même si aucun réglage de volume n'est approprié pour tous, vous devez toujours régler le volume d'écoute à une intensité modérée et éviter d'utiliser un volume élevé de façon prolongée. Plus le volume est élevé, plus vous risquez d'endommager rapidement votre audition. Le volume du micro-casque peut varier selon l'appareil auquel il est couplé. L'appareil que vous utilisez ainsi que ses paramètres modifient le volume. Si vous ressentez une gêne auditive, arrêtez d'utiliser le micro-casque et consultez un médecin. Pour protéger votre audition, voici ce que des experts en matière d'audition recommandent :

1. Réglez le volume à bas niveau avant de placer le micro-casque sur vos oreilles et utilisez-le au volume le plus bas possible.
2. Évitez d'augmenter le volume pour vous isoler des bruits environnants. Utilisez de préférence le micro-casque dans un endroit tranquille, sans trop de bruits de fond.
3. Utilisez à volume élevé le moins longtemps possible.
4. Baissez le volume si le son provenant du micro-casque vous empêche d'entendre les personnes qui parlent autour de vous. Pour obtenir de plus amples renseignements sur les micro-casques et l'audition, consultez le site <http://www.plantronics.com/healthandsafety>.

Avertissements relatifs au chargeur
• Utilisez uniquement le chargeur fourni par Plantronics pour charger le produit. N'utilisez le chargeur à aucune autre fin. Assurez-vous que la tension nominale correspond à l'alimentation que vous voulez utiliser, par exemple 100-240 V, 50/60 Hz, 0,2 A.
• Chargez le micro-casque selon les instructions fournies avec l'appareil.
• Branchez l'adaptateur ou le chargeur c.a. dans une prise suffisamment près et facilement accessible.
• Ne rangez ou n'utilisez jamais le produit dans un endroit où la température pourrait tomber sous 0 °C.

Pile de micro-casque - Avertissements
• Pour éviter les risques d'explosion, d'incendie ou de fuite de produits chimiques toxiques, tenez compte des avertissements suivants :
• Ne jetez pas le produit au feu et ne l'exposez pas à une chaleur excédant 40 °C (104 °F).
• Ne tentez pas d'ouvrir ou de perforer la pile. Elle peut contenir des matières corrosives toxiques pouvant causer des blessures aux yeux et à la peau.
• Gardez toujours les piles hors de portée des enfants.
• Si le produit est équipé d'une pile interne non remplaçable c'est qu'il n'est pas conçu pour durer plus longtemps que cette pile. Ne tentez pas d'ouvrir le produit ou de retirer la pile afin d'éviter tout dommage ou toute blessure éventuelle. Veuillez communiquer avec votre centre de recyclage pour retirer la pile.
• Si votre micro-casque est doté d'une pile remplaçable, utilisez uniquement la pile livrée avec le produit. Retirez rapidement la pile lorsqu'elle est usée.
• Évitez tout contact entre une pile ou un porte-pile et des objets métalliques, tels que des clés ou de la monnaie.
RECYCLAGE: Le micro-casque et les piles doivent être recyclés ou éliminés de la façon appropriée. Communiquez avec le centre de recyclage de votre région afin de mettre votre micro-casque au rebut de façon appropriée.

Exposition à RF Radiation
The internal wireless radio operates within the guidelines found in radio frequency safety standards and recommendations, which reflect the consensus of the scientific community. Independent studies have shown that the internal wireless radio is safe for use by consumers. Visit plantronics.com for more information.
In order to comply with IC RF Exposure requirements, the base must be installed and operated such that a minimum separation distance of 20 cm is maintained between the base and all persons during normal operation. The headset complies with FCC radiation limit set forth for an uncontrolled environment.
NOTE: Modifications not expressly approved by Plantronics, Inc. could void the user's authority to operate the equipment.
Industry Canada Regulatory Information
This product meets the applicable Industry Canada technical specifications/Le présent matériel est conforme aux spécifications techniques applicables d'Industrie Canada.
This Class B digital apparatus complies with Canadian ICES-003. Operation is subject to the following two conditions: (1) this device may not cause interference, and (2) this device must accept any interference, including interference that may cause undesired operation of the device.

Cet appareil numérique de la classe B est conforme à la norme NMB-003 du Canada. Le présent appareil est conforme aux CNR d'Industrie Canada applicables aux appareils radio exempts de licence. L'exploitation est autorisée aux deux conditions suivantes: (1) l'appareil ne doit pas produire de brouillage, et (2) l'utilisateur de l'appareil doit accepter tout brouillage radioélectrique subi, même si le brouillage est susceptible d'en compromettre le fonctionnement.
Exposition to RF Radiation
Cet équipement est conforme aux limites d'exposition de radiation IC (encadré) pour un environnement non contrôlé.

1 Selezione o estilo de uso

1 Escolhe o estilo de uso do seu; usa o guia para montagem.

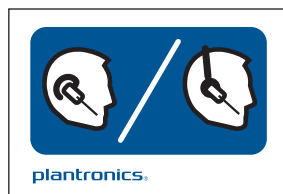

Sobre o ouvido OU Sobre a cabeça

2 Carregue o headset

1 Conecte uma extremidade da fonte de alimentação na entrada de energia, na parte posterior da base, e a outra extremidade em uma tomada que esteja funcionando.

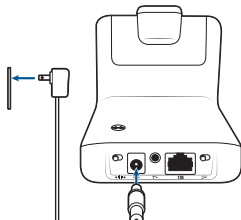

2 Para carregar, encaixe o headset na base por, no mínimo, 20 minutos.

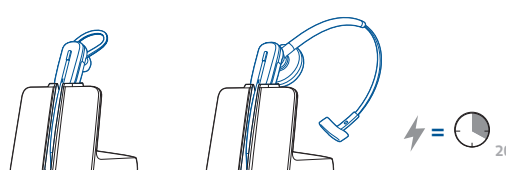

3 Conectar o telefone de mesa

1 Conecte os cabos do telefone de mesa à base.

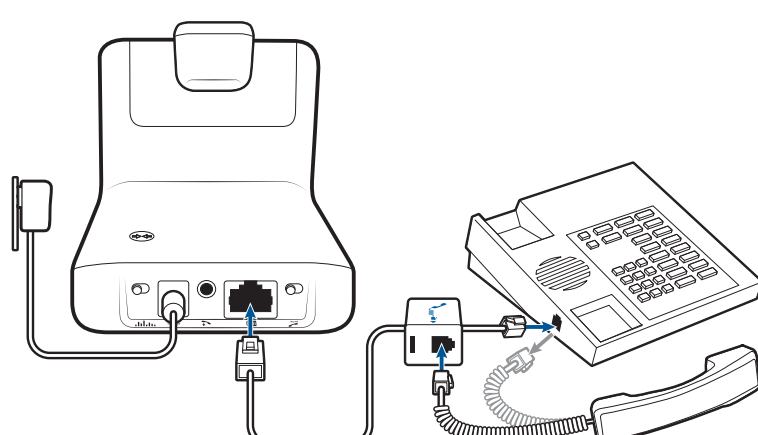

4 Fazer uma chamada

1 Usando o headset, toque no botão de controle de chamada.

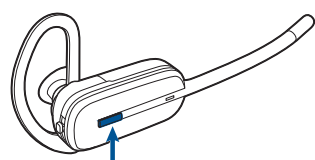

2 Remova o monofone do seu telefone de mesa.

3 Faça uma chamada do telefone de mesa.

4 Para finalizar a chamada, pressione o botão de controle do headset e reponha o monofone no gancho.

Dica para solução de problemas: Caso não ouça o tom de discagem, ajuste a chave (A-G) até ouvi-lo. Configuração padrão **A** funciona para a maioria dos telefones de mesa.

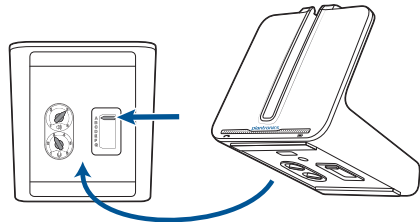

NOTA Para o recurso de controle de chamada remoto (suporte HL10 ou cabo EHS), consulte plantronics.com/accessories.

PRECISA DE MAIS AJUDA?

Suporte técnico
plantronics.com/support
Guia do usuário on-line
<http://docs.plantronics.com/cs500>

Recursos do sistema

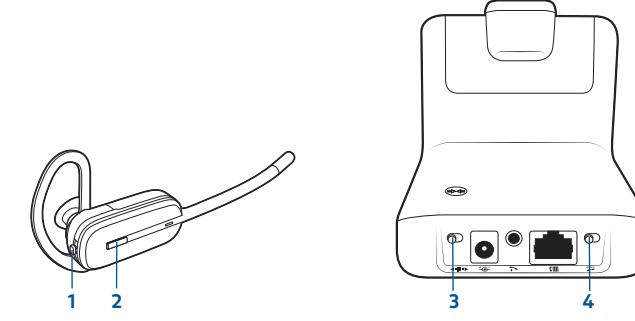

1 Botão de volume/interrupção do som

Pressione para cima para aumentar o volume*
Pressione para baixo para diminuir volume*
*Se o headset for usado no lado esquerdo, as posições para aumentar e diminuir o volume serão invertidas.

Interrupção do som (LED da base - vermelho constante)

2 Botão de controle de chamadas

Toque em atender/finalizar chamada

3 Comutador de áudio em banda estreita/larga

Preto Áudio em banda estreita

Amarelo Áudio em banda larga (o telefone de mesa deve estar apto para áudio de banda larga)

NOTA: O tempo de conversação será reduzido quando estiver operando em modo de banda larga.

4 Chave Atendimento automático

Preto (desligado) Toque no botão de controle de chamada para fazer ou atender uma chamada

Cinza (ligado) Retire o headset da base para fazer ou atender uma chamada

O CS540S consiste em uma base C054S e um headset CS40S.

Garantia limitada
Plantronics oferece um (1) ano de garantia limitada para este produto. Lembre-se de que a duração da garantia depende da legislação do seu país. Para mais detalhes e condições sobre a garantia, visite o nosso site: plantronics.com. Embratel 0800-891-3451

Instruções de Segurança
Leia as informações de segurança e operacionais a seguir antes de usar este produto. Guarde essas instruções para referência futura. Ao usar o seu produto, siga estes avisos e estas precauções básicas de segurança para reduzir o risco de incêndio, choque elétrico, ferimentos e danos patrimoniais. Outros avisos poderão estar presentes no produto, na embalagem ou nas instruções para o usuário.

Geral
A temperatura de operação, armazenamento e carga varia de 0°C a 40°C (32°F a 104°F).

Avisos
• Utilize somente os produtos e acessórios Plantronics destinados ao uso com este sistema Plantronics.
• CRIANÇAS: Nunca permita que as crianças brinquem com o produto—pequenas partes podem ser prejudiciais.
• Instale e use pontas auriculares e fones de acordo com as instruções fornecidas. Não force pontas auriculares ou fones para dentro do canal auricular. Se um deles ficar alojado no canal auricular, consulte o médico imediatamente.
• Mantenha as pontas auriculares e os fones limpos e sem acúmulo de cera de ouvido para manter o desempenho especificado do produto.
• Observe todas as sinalizações e instruções quanto ao uso de um dispositivo elétrico ou um produto de radiação de radio-freqüência em áreas designadas, como postos de gasolina, hospitais, áreas inflamáveis, ambientes com risco de explosão ou aeronaves.
• Não desmonte o produto ou o adaptador CA, pois isso pode expor você a tensões perigosas ou outros riscos. A remontagem incorreta poderá causar choque ou incêndio quando o produto voltar a ser usado.
• Não coloque nada dentro do produto ou do carregador, pois isso poderá causar danos aos componentes internos ou provocar ferimentos em você.
• Evite o contato do produto com substâncias líquidas. Não coloque este produto em locais em que haja água, como por exemplo, próximo a banheiras, piscinas ou em porões úmidos, para protegê-lo contra danos ou se proteger contra ferimentos.
• Interrompa o uso do produto e entre em contato com a Plantronics caso ele apresente superaquecimento, danos no cabo ou no plugue, caia no chão, seja danificado ou entre em contato com substâncias líquidas.
• Este produto nunca deve ser colocado sobre ou próximo a fontes de calor ou que não tenham ventilação adequada.
• Caso você tenha irritação na pele após usar o produto, descontinue o uso e entre em contato com a Plantronics.
• A exposição a níveis de som de alto volume pode prejudicar a audição temporária ou permanentemente. Embora não haja uma única configuração de volume apropriada para todas as pessoas, é recomendável usar sempre o headset com o volume ajustado em níveis moderados e evitar uma longa exposição a níveis de som de alto volume. Quanto mais alto o volume, menos tempo será necessário para afetar sua audição. Você poderá perceber diferentes níveis de som ao usar o headset com dispositivos distintos. O dispositivo usado e suas configurações afetam o nível de som ouvido. Caso sinta alguma dificuldade de audição, você deverá parar de ouvir o dispositivo por intermédio do headset e procurar um médico. Para proteger sua audição, alguns especialistas sugerem o seguinte:

1. Ajuste o controle de volume para um nível baixo antes de colocar o headset, e utilize o volume mais baixo possível.
2. Evite aumentar o volume para bloquear ambientes barulhentos. Sempre que possível, use o seu headset em um ambiente silencioso, com baixo nível sonoro no fundo.

3. Limite o tempo de uso de headsets em níveis de volume altos.

Avisos sobre carregamento
• Use apenas o carregador fornecido pela Plantronics para carregar o produto. Não use os carregadores para outras finalidades. Verifique se a voltagem corresponde à fonte de alimentação que você pretende usar, por exemplo, 100-240 V, 50/60 Hz, 0,2 A.
• Carregue o headset de acordo com as instruções fornecidas com a unidade.
• Conecte o adaptador CA ou o carregador em uma tomada que esteja próxima ao equipamento e que seja facilmente acessível.
• Nunca armeze ou use o produto, ou carregue a bateria, quando a temperatura estiver abaixo de 0°C (32°F) ou acima de 40°C (104°F).

Cuidados com a bateria do headset
Para evitar o risco de explosão, incêndio ou vazamento de substâncias químicas tóxicas, confira os seguintes avisos:
• Não descarte o produto ou a bateria no fogo ou a uma temperatura acima de 40°C (104°F).
• Não abra, deforme nem corte a bateria. A célula contém materiais corrosivos que podem causar danos aos olhos e à pele, além de serem tóxicos se ingeridos.
• Sempre guarde baterias longe do alcance de crianças.
• Se o produto possuir uma bateria incorporada não substituível, ela foi desenvolvida para durar por toda a vida útil do produto. Não tente abrir o produto e remover a bateria, pois isso pode provocar ferimentos ou causar danos ao produto. Entre em contato com o centro de reciclagem de sua região para recolher a bateria.
• Se o seu produto tiver bateria substituível (não-recarregável), use somente o tipo de bateria fornecido pela Plantronics.
• Remova a bateria gasta imediatamente.
• Não permita que nenhuma bateria ou seu suporte entre em contato com objetos, como chaves ou moedas.

RECYCLAGE: Seu headset e/ou a bateria devem ser reciclados ou descartados de forma apropriada. Entre em contato com o centro de reciclagem de sua região para descartar apropriadamente o seu headset.

Homologação Anatel

Este produto está homologado pela ANATEL, de acordo com os procedimentos regulamentados pela resolução 242/2000, e atende aos requisitos técnicos aplicados.

Para maiores informações consulte o site da ANATEL.

<http://www.anatel.gov.br>



1488-11-1893



* ESTE EQUIPAMENTO OPERA EM CARÁTER SECUNDÁRIO. ISTO É, NÃO TEM DIREITO A PROTEÇÃO CONTRA INTERFERÊNCIA PREJUDICIAL, MESMO DE ESTAÇÕES DO MESMO TIPO E NÃO PODE CAUSAR INTERFERÊNCIA A SISTEMAS OPERANDO EM CARÁTER PRIMÁRIO. *

Distribuído por Plantronics Telecomunicações Ltda
CNPJ 05.758.913/0001-95